

Tube
ComfoPipe Compact (L=1000 mm)



Manchon
ComfoPipe Compact



Coude à 45°
ComfoPipe Compact



Adaptateur

Utilisation

Zehnder ComfoPipe Compact a été conçu pour le transport de l'air neuf et de l'air vicié entre l'unité de ventilation double flux Zehnder ComfoAir et, d'une part, les grilles ou chapeaux de toit et, d'autre part, les caissons de distribution et silencieux.

Son matériau, le polypropylène expansé, permet d'éviter la formation de condensation sur la paroi externe du produit.

Zehnder ComfoPipe Compact évite les ponts thermiques dans le réseau de distribution d'air grâce à ses jonctions étanches et isolées (EPP). Zehnder ComfoPipe Compact a été conçu pour générer des pertes de charge minimales. Son installation est simple et ne nécessite pas d'outils particuliers.

Avantages

- Léger et facilement découppable (Traits de découpe tous les 5 cm)
- Encombrement réduit (Gain de 30mm d'encombrement comparé à l'ancienne version ComfoPipe)
- Rigide, ne se déforme pas, haute résistance à l'écrasement, utilisation réduite de collier de soutien
- Haut pouvoir isolant (15 mm d'isolation)
- Étanche (Tube en 125, 160 et 200 en Classe D)
- Montage facile sans scotch ni colle
- Polypropylène expansé moulé à chaud, sans COV.

Spécifications

Epaisseur du matériau	15 mm
Conduction Thermique	0,037 W/mK
Coefficient U	2,467 W/(m²K)
Plage d'utilisation	-25° 60°

Références

Désignation	N° d'art.
ComfoPipe Compact 125 Tube L=1000 mm, DN 155/125	990 328 690
ComfoPipe Compact 160 Tube L=1000 mm, DN 190/160	990 328 693
ComfoPipe Compact 200 Tube L=1000 mm, DN 230/200	990 328 696
ComfoPipe Compact 125 Coude 45° DN 155/125	990 328 691
ComfoPipe Compact 160 Coude 45° DN 190/160	990 328 694
ComfoPipe Compact 200 Coude 45° DN 230/200	990 328 697
ComfoPipe Compact 125 Manchon DN 155/125	990 328 692
ComfoPipe Compact 160 Manchon DN 190/160	990 328 695
ComfoPipe Compact 200 Manchon DN 230/210	990 328 698

Zehnder ComfoPipe Compact

Conduit de ventilation

Ed.a

Pertes de charge

ComfoPipe Compact 125 : Tube

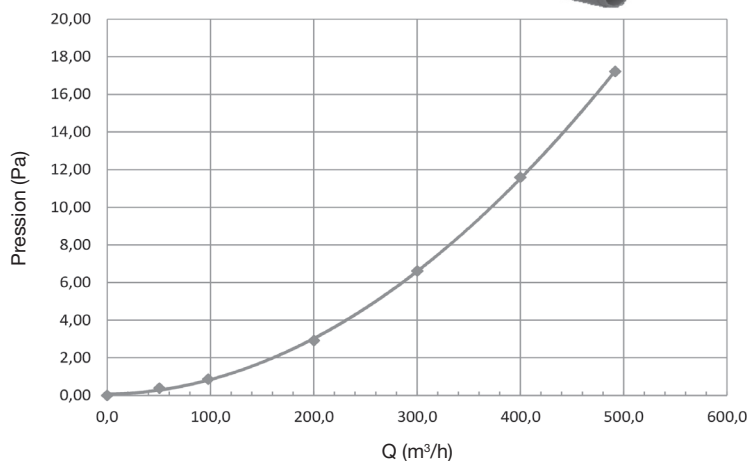

Q (m³/h)	P (Pa)
50,5	0,38
97,8	0,86
200,1	2,91
300,3	6,61
400,0	11,59
491,8	17,21

ComfoPipe Compact 125 : Coude 45°

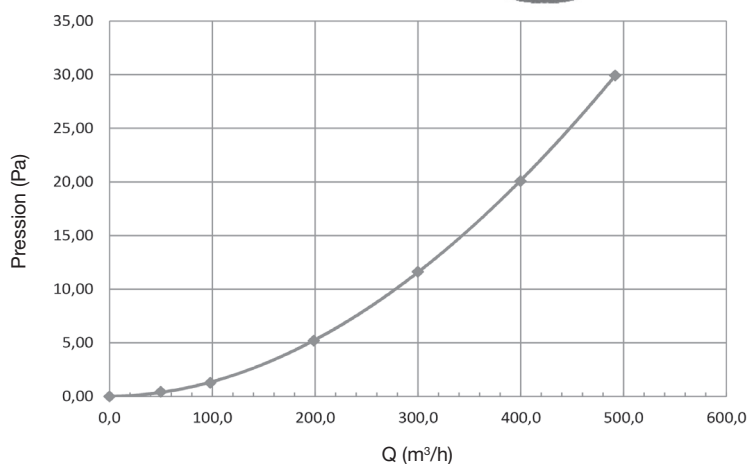

Q (m³/h)	P (Pa)
49,7	0,43
98,0	1,27
198,6	5,20
299,9	11,62
399,7	20,08
491,9	29,93

ComfoPipe Compact 125 : 2 coudes 45°

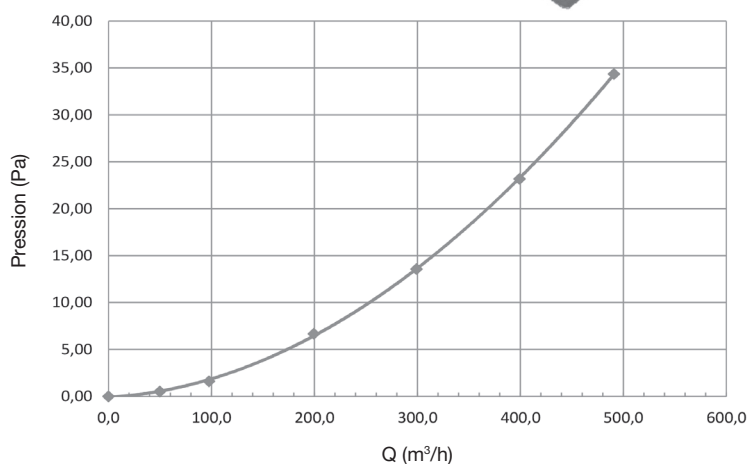

Q (m³/h)	P (Pa)
49,8	0,51
97,6	1,61
199,4	6,68
299,1	13,57
399,2	23,17
490,9	34,35

Zehnder ComfoPipe Compact

Conduit de ventilation

Ed.a

Pertes de charge

ComfoPipe Compact 160 : Tube

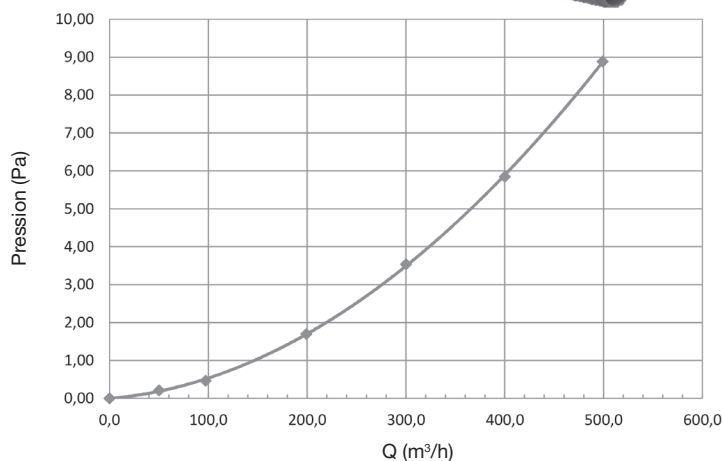

Q (m³/h)	P (Pa)
50,2	0,21
97,2	0,47
199,2	1,70
300,1	3,54
400,1	5,85
499,1	8,89

ComfoPipe Compact 160 : Coude 45°

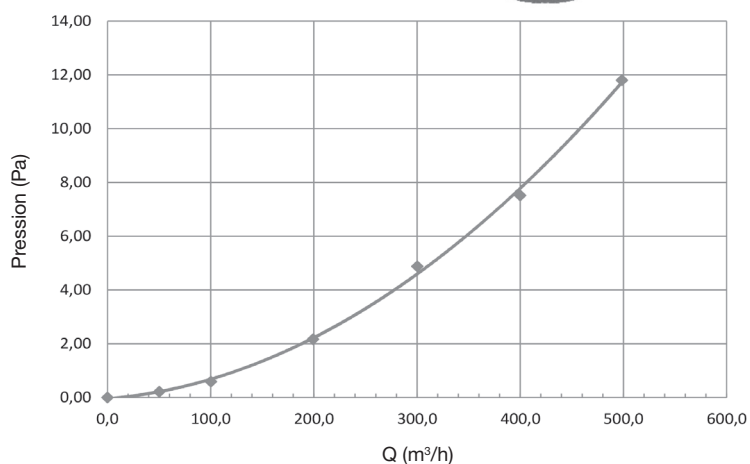

Q (m³/h)	P (Pa)
50,2	0,22
100,3	0,59
199,2	2,17
300,3	4,88
400,0	7,52
498,5	11,80

ComfoPipe Compact 160 : 2 coudes 45°

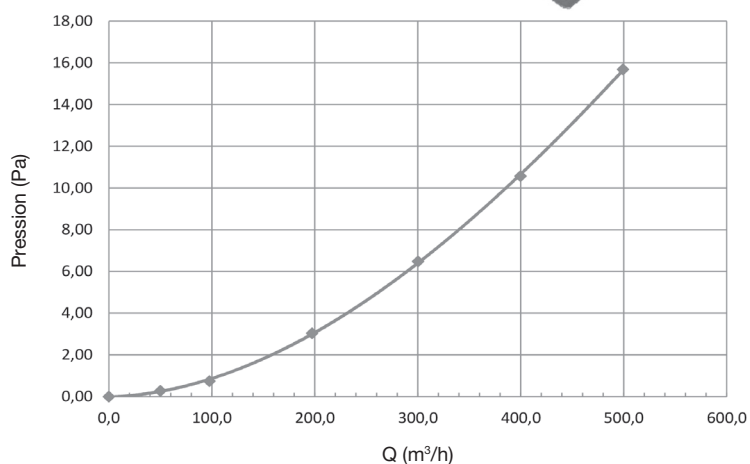

Q (m³/h)	P (Pa)
50,0	0,28
97,6	0,74
197,3	3,04
300,3	6,48
399,8	10,57
499,4	15,68

Zehnder ComfoPipe Compact

Conduit de ventilation

Ed.a

Pertes de charge

ComfoPipe Compact 200 : Tube

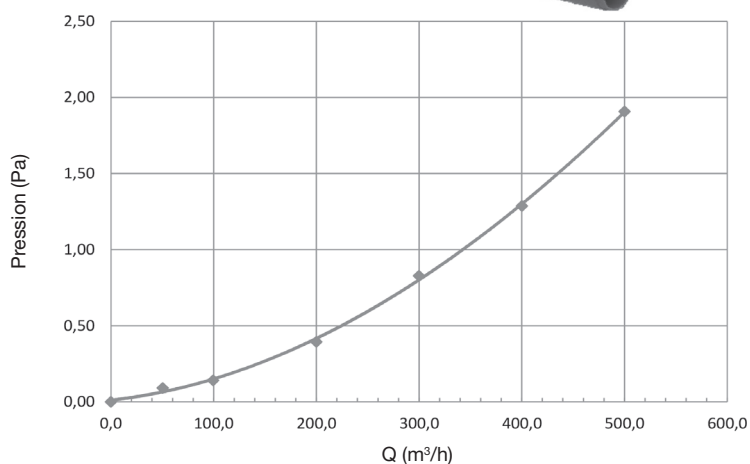

Q (m³/h)	P (Pa)
50,4	0,09
99,4	0,14
199,9	0,39
299,8	0,83
400,2	1,29
500,1	1,91

ComfoPipe Compact 200 : Coude 45°

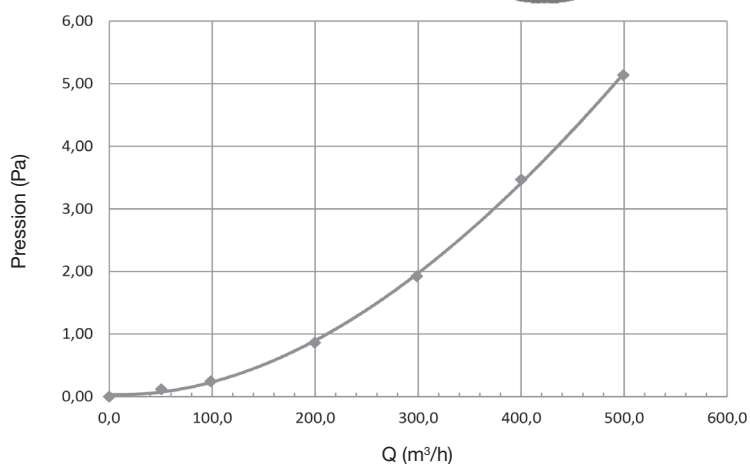

Q (m³/h)	P (Pa)
50,5	0,12
98,6	0,24
199,5	0,86
298,6	1,92
400,2	3,47
499,2	5,14

ComfoPipe Compact 200 : 2 coudes 45°

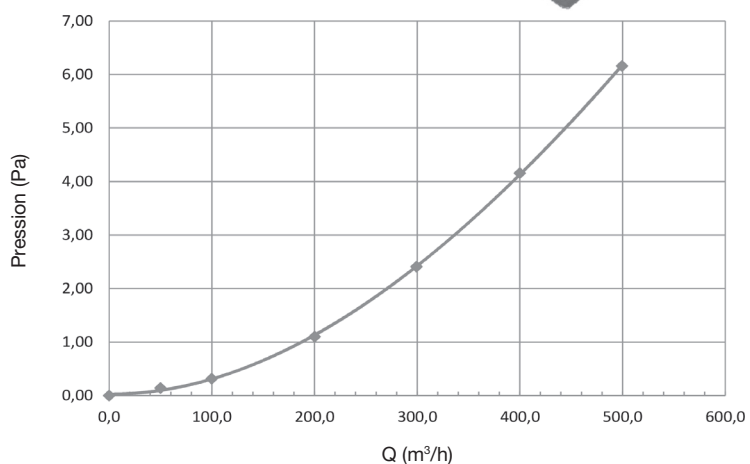

Q (m³/h)	P (Pa)
50,0	0,14
99,8	0,31
200,1	1,10
299,2	2,41
400,0	4,16
499,5	6,16

Zehnder ComfoPipe Compact

Conduit de ventilation

Ed.a

Test d'étanchéité

ComfoPipe Compact 125 : Tube

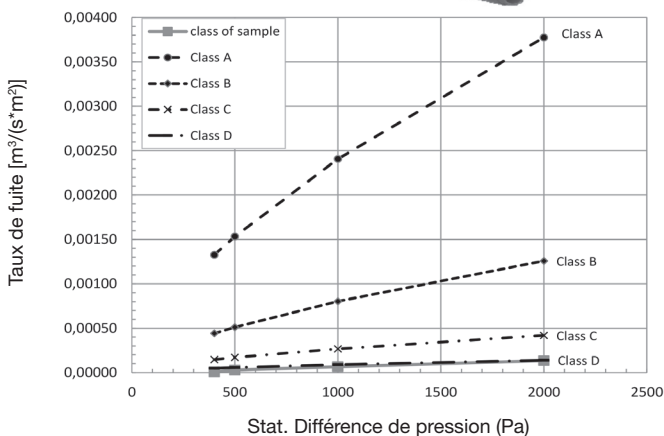

ComfoPipe Compact 125 : Tube coupé et assemblé

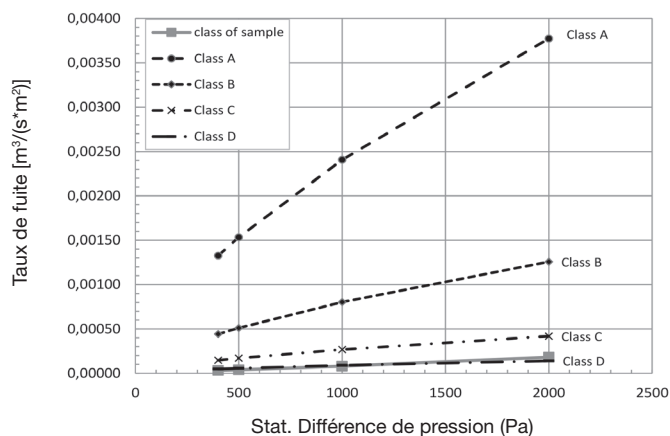

ComfoPipe Compact 125 : Coude 45°

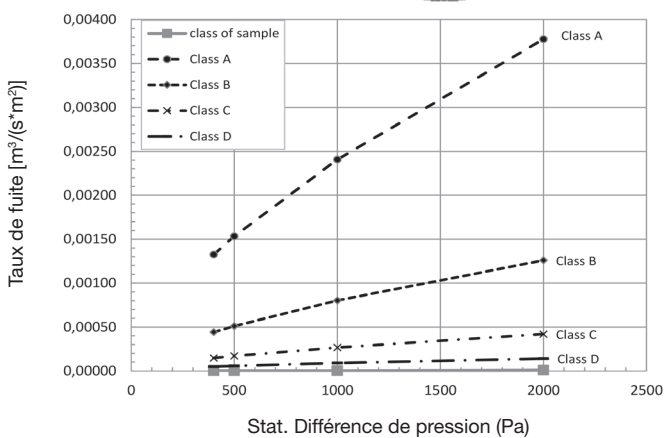

ComfoPipe Compact 125 : 2 Coudes 45°

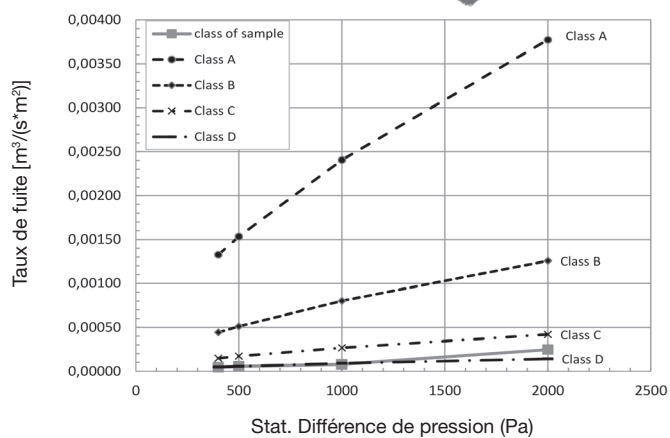

ComfoPipe Compact 125 : Manchon

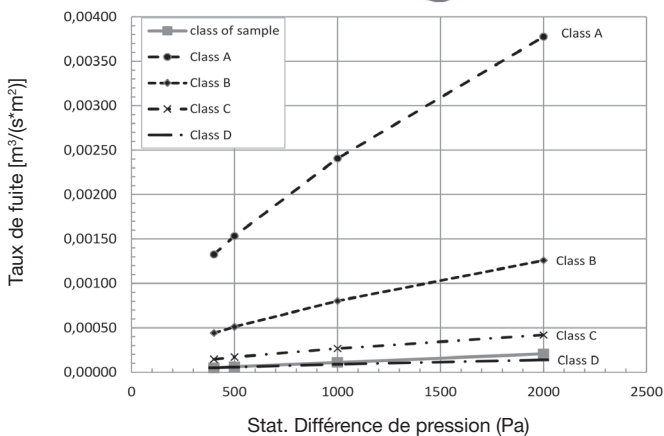

Test d'étanchéité

ComfoPipe Compact 160 : Tube

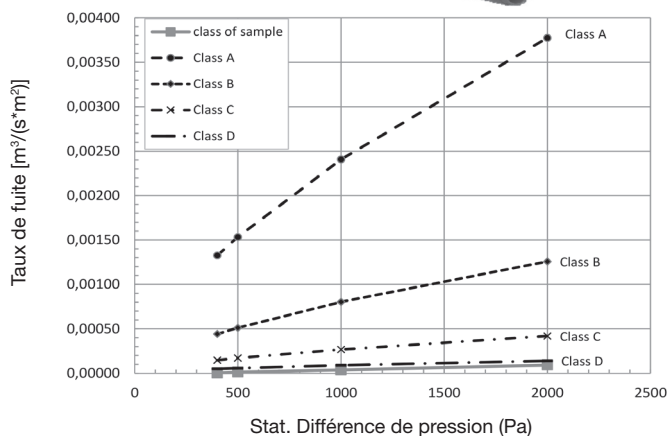

ComfoPipe Compact 160 : Tube coupé et assemblé

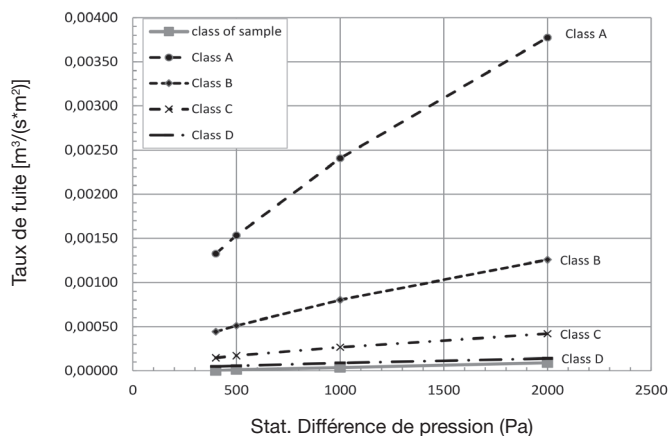

ComfoPipe Compact 160 : Coude 45°

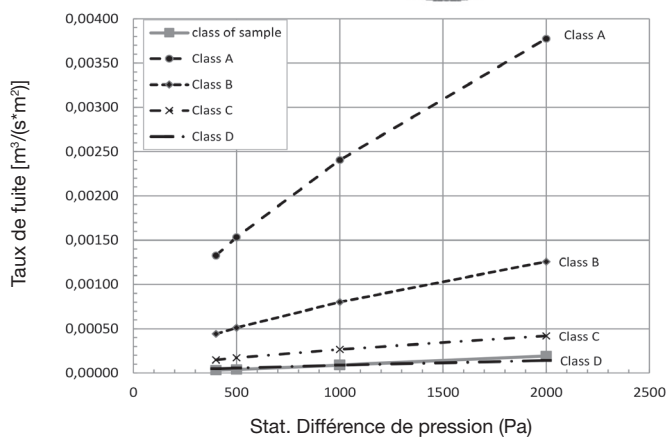

ComfoPipe Compact 160 : 2 Coudes 45°

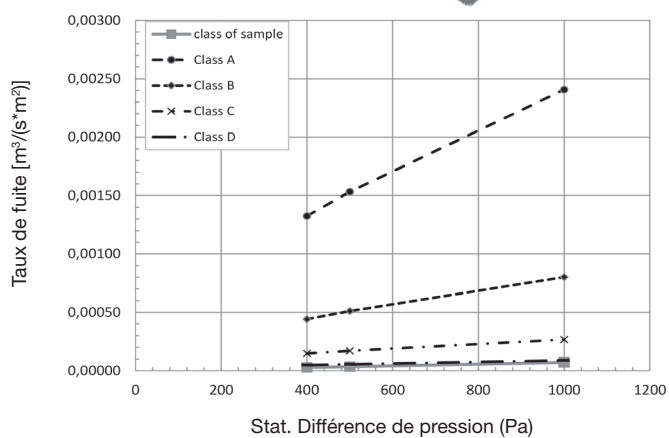

ComfoPipe Compact 160 : Manchon

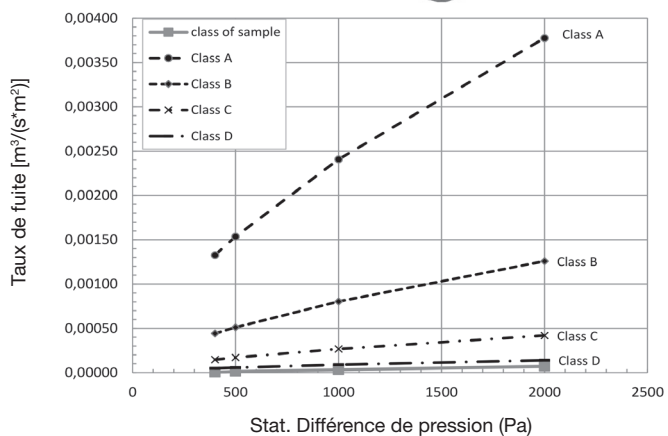

Zehnder ComfoPipe Compact

Conduit de ventilation

Ed.a

Test d'étanchéité

ComfoPipe Compact 200 : Tube

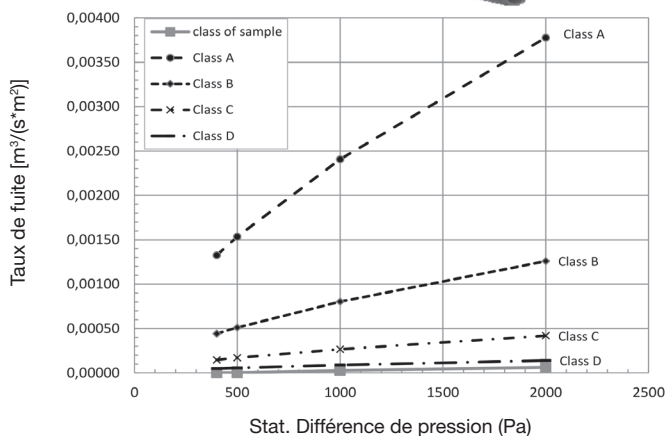

ComfoPipe Compact 200 : Tube coupé et assemblé

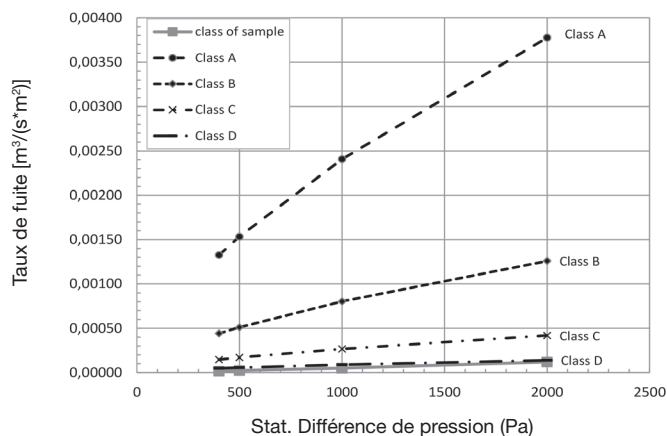

ComfoPipe Compact 200 : Coude 45°

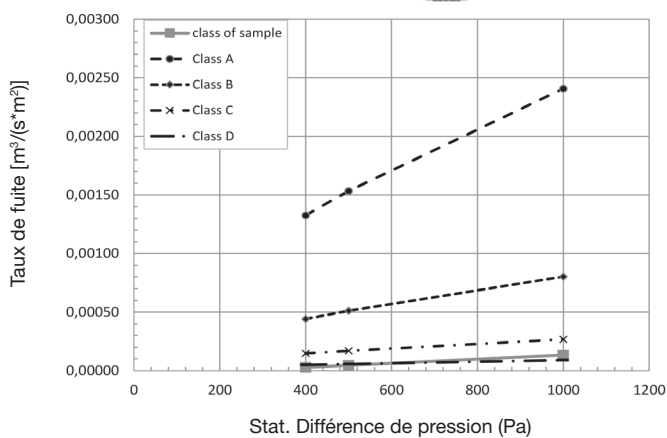

ComfoPipe Compact 200 : 2 Coudes 45°

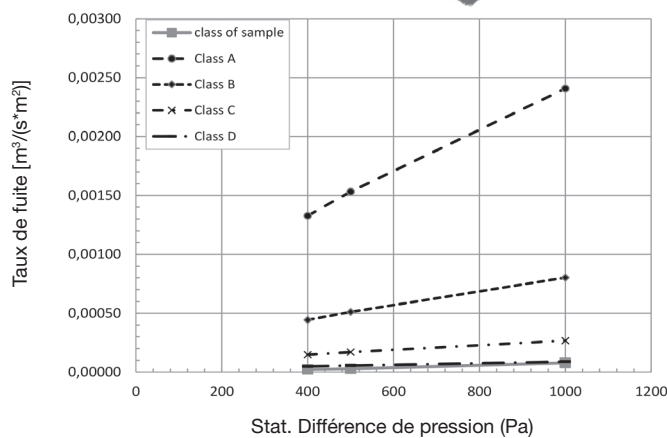

ComfoPipe Compact 200 : Manchon

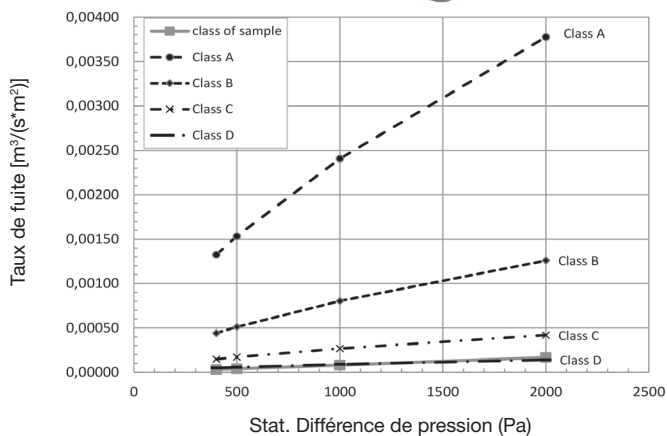

Schémas cotés

Tube

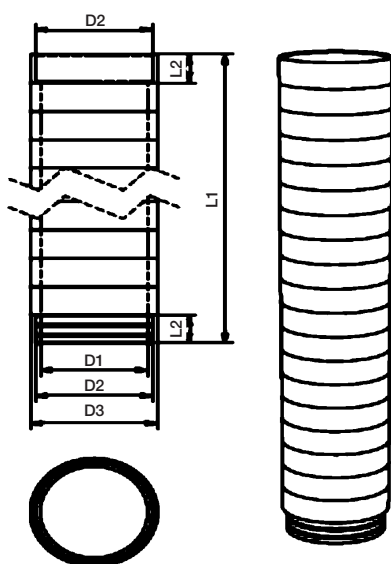

Tube	L1	L2	D1	D2	D3
DN 125	1000	50	125	140	155
DN 160	1000	50	160	175	190
DN 200	1000	50	200	215	230

Coude à 45°

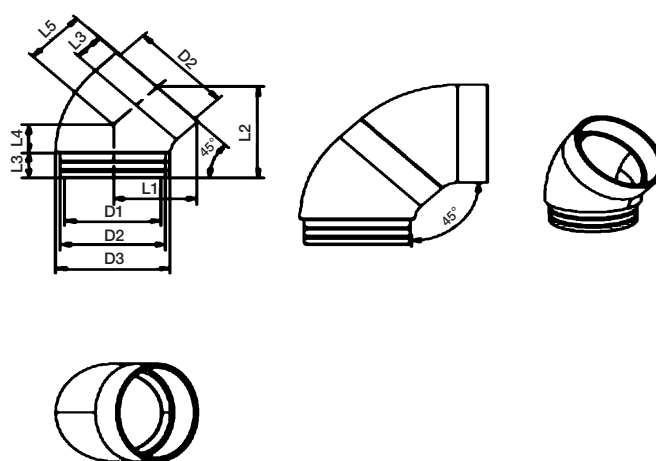

Coude à 45°	L1	L2	L3	L4	L5	D1	D2	D3
DN 125	118	207	50	40	98	125	140	155
DN 160	140	244	50	55	104	160	175	190
DN 200	166	205	50	71	120	200	215	230

Manchon

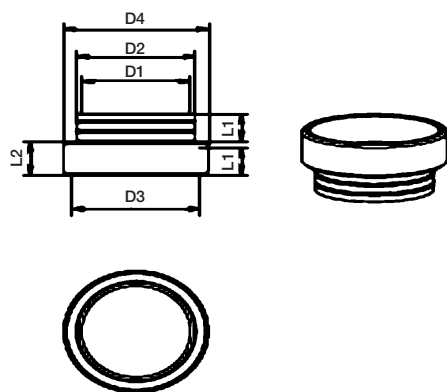

Manchon	L1	L2	D1	D2	D3	D4
DN 125	50	60	125	140	155	179
DN 160	50	60	160	175	190	214
DN 200	50	60	200	215	230	254

Coude à 45°

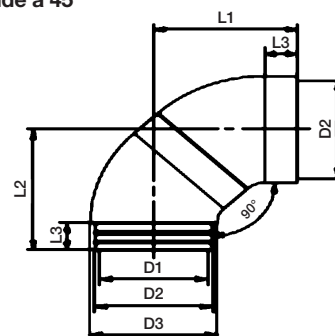

Coude à 45°	L1	L2	L3	D1	D2	D3
DN 125	118	207	50	125	140	155
DN 160	140	244	50	160	175	190
DN 200	166	205	50	200	215	230